

HAYMAN REESE
PART No: 03113RW
SUBARU OUTBACK/LIBERTY

INSTALLATION INSTRUCTIONS

PLEASE ENSURE THAT ALL INSTRUCTIONS ARE UNDERSTOOD PRIOR TO FITMENT
PLACE THESE INSTRUCTIONS IN THE VEHICLE'S GLOVEBOX AFTER INSTALLATION IS COMPLETED



Installation Time: Approx. 90 Mins

Towbar Installation Instructions

Towbar capacity

SUBARU OUTBACK/LIBERTY

Part Number 03113RW

Max Towing Braked 1800 kg

Max Towing Unbraked 750 kg

Max Static Ball Load 180 kg

Hayman Reese (Cequent)
PO Box 4050, Dandenong South VIC 3164
Phone 1800 812 017 Email info@haymanreese.com.au

HAYMAN REESE
PART No: 03113RW
SUBARU OUTBACK/LIBERTY

INSTALLATION INSTRUCTIONS

PLEASE ENSURE THAT ALL INSTRUCTIONS ARE UNDERSTOOD PRIOR TO FITMENT
PLACE THESE INSTRUCTIONS IN THE VEHICLES'S GLOVEBOX AFTER INSTALLATION IS COMPLETED

Warning:

1. Do not, drill, cut, weld or otherwise modify the towbar.
2. If you are using electric welding on a motor vehicle, **always** check that the vehicle is not equipped with electronic engine or instrument management equipment. Failure to do so could **destroy** any onboard computers. If in doubt, check with the vehicle's manufacturer.
3. If TBM is used in inverted position tow ball may make contact with rear tailgate when lowered, which could cause damage.

General:

1. Ensure all hardware items have been included refer to assembly diagram.
2. It is recommended that the instructions are read through and completely understood before making any attempt to fit this product.
3. Be wary of any changes to vehicle designs or other accessories that may conflict with the installation of this product.
4. Before drilling ensure that the area is clear of fuel, electrical & other components.
5. All holes drilled into the body panels shall have all burrs & swarf removed then coated with a suitable rust preventative paint.
6. The high tensile fasteners supplied with this product were used to achieve the specified rating. If replacement is required ensure that fasteners of the same rating & quality are used. Contact an authorised **Hayman Reese** dealer if further information is required.
7. Ensure that all hardware is fastened to torque list below check fasteners on regular basis.
8. Towbar load rating sticker provided with this product shall be conspicuously located on inside rear end of the driver's door. **(See diagram below).**
9. Hayman Reese recommends that you check your tow ball to ensure that it complies with the Australian standards **AS 4177.2**.
10. **PLEASE NOTE:** It is advised to remove your LUG or TBM when not actually towing so as to produce a clear view of the vehicles registration plate if obscured, and to also provide maximum available departure angle.
11. Pull Pin must be fit in down position.

Tow bar Maintenance and Care.

Hayman Reese recommends that bolt torque's, as listed below, are routinely and regularly inspected and checked for correct tension. Replace any worn or defective parts.

We recommended to remove Tow Ball Mounts (TBM's, tongues or lugs) when not being used for any considerable length of time.

So as to avoid injury, when not towing it is suggested that the tongue, Pull Pin and R-clip are removed then stored in a safe, clean and dry place, away from excessive moisture.

Hitch Pull Pins and spring "R" clips are regularly checked for proper installation. Replace any worn or defective parts.

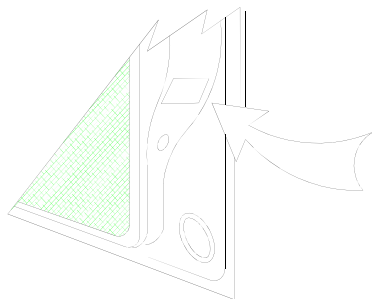

Place load rating sticker
inside driver's door here

RECOMMENDED ASSEMBLY TORQUE LISTING

Diameter Grade 8.8 Bolt

M6	9.5 Nm
M8	21.7 Nm
M10	43.4 Nm
M12	77.3 Nm
M14	146 Nm
M16	189.8 Nm

FOR TOWING PURPOSES ONLY

For towing capacity details please refer to vehicle owner's manual or to the manufacturer. Overloading can void your warranties.

HAYMAN REESE

PART No: 03113RW

SUBARU OUTBACK/LIBERTY

INSTALLATION INSTRUCTIONS

PLEASE ENSURE THAT ALL INSTRUCTIONS ARE UNDERSTOOD PRIOR TO FITMENT
PLACE THESE INSTRUCTIONS IN THE VEHICLE'S GLOVEBOX AFTER INSTALLATION IS COMPLETED

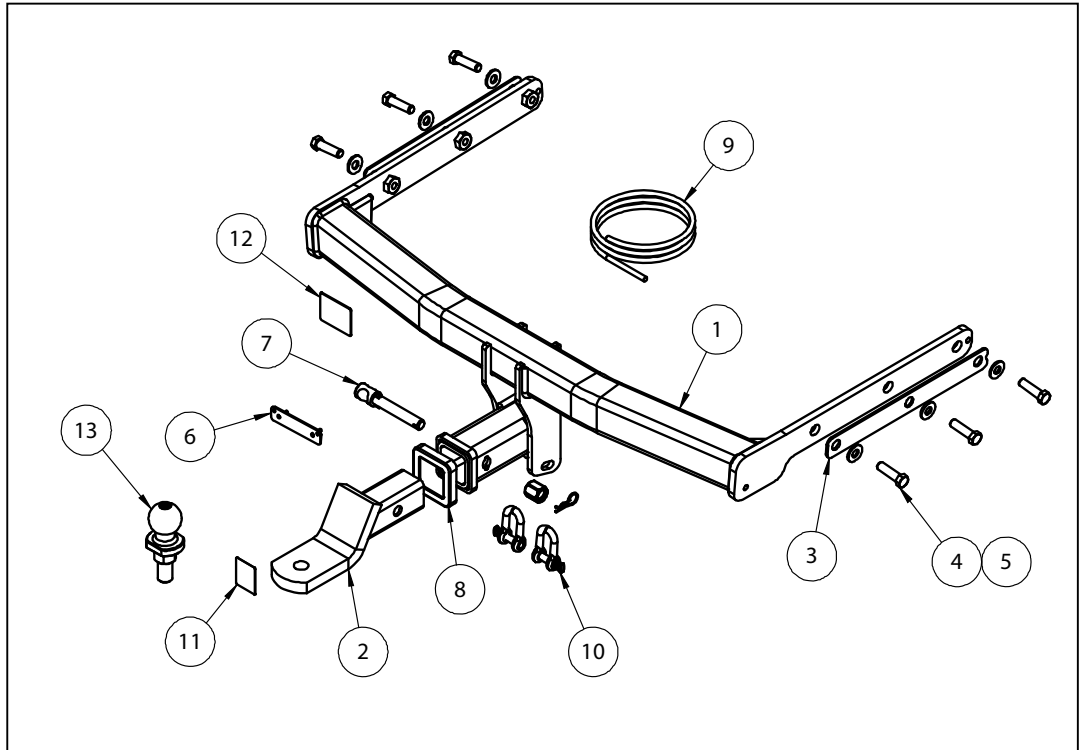

QTY.	DESCRIPTION	ITEM NO.
1	WELDED ASSY	1
1	CLASS4 TBM ASSY	2
2	SPACER PLATE	3
6	BOLT M12x45 1.75P	4
6	WASHER FLAT M12	5
1	PLUG BRACKET	6
1	ANTI RATTLE PULL PIN ASSY GOLD	7
1	HITCH BOX COLLAR COVER	8
1	WIRING LOOM	9
2	D SHACKLE 10mm	10
1	HR STICKER	11
1	ACRYLIC COMPLIANCE PLATE	12
1	HR TOWBALL	13

HAYMAN REESE
PART No: 03113RW
SUBARU OUTBACK/LIBERTY

INSTALLATION INSTRUCTIONS

PLEASE ENSURE THAT ALL INSTRUCTIONS ARE UNDERSTOOD PRIOR TO FITMENT
PLACE THESE INSTRUCTIONS IN THE VEHICLES'S GLOVEBOX AFTER INSTALLATION IS COMPLETED

1. Remove 3x Screws from the LHS mud flap on the inside of the wheel arch.

Remove 1x Scrivet located on the underside of the mud flap cover, and place the mud flap aside.

Repeat for RHS.

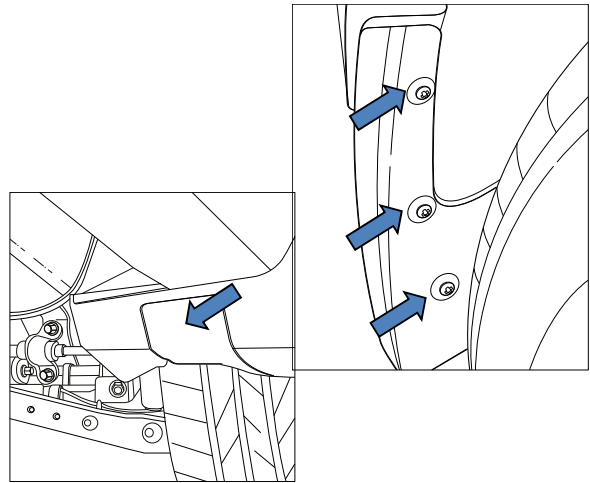

2. Remove 1x pop Scrivet from the top of the LHS wheel arch.

Repeat for RHS.

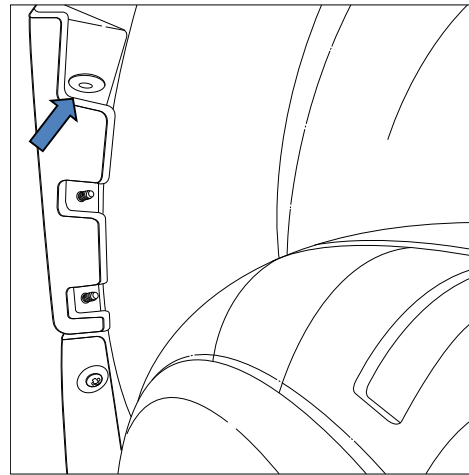

3. Remove 7x Scrivets from the underside of the bumper.

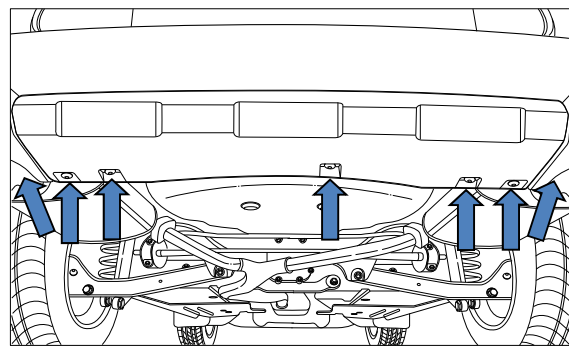

HAYMAN REESE
PART No: 03113RW
SUBARU OUTBACK/LIBERTY

INSTALLATION INSTRUCTIONS

PLEASE ENSURE THAT ALL INSTRUCTIONS ARE UNDERSTOOD PRIOR TO FITMENT
PLACE THESE INSTRUCTIONS IN THE VEHICLES'S GLOVEBOX AFTER INSTALLATION IS COMPLETED

4. Remove 2x Scrivets from the LHS taillight cover.

Set the taillight cover aside and remove 2x Screws from the LHS taillight.

Dislodge the LHS taillight, disconnect the wiring and remove the LHS taillight assembly.

Repeat for RHS.

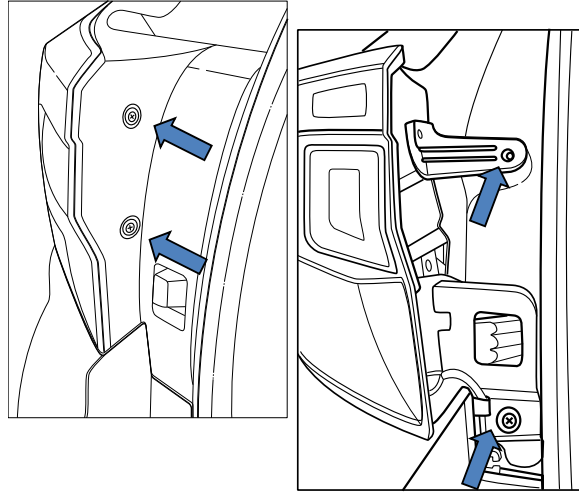

5. Remove 1x Screw below the taillight on the LHS of the bumper.

Repeat for RHS.

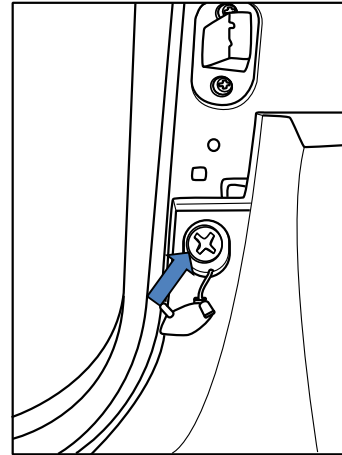

6. Remove the Bumper via unclipping the sides and pulling firmly.

When removing the bumper, ensure any wiring is disconnected.

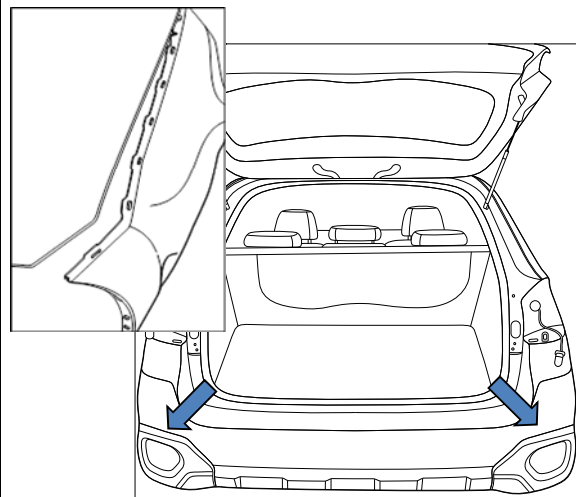

INSTALLATION INSTRUCTIONS

PLEASE ENSURE THAT ALL INSTRUCTIONS ARE UNDERSTOOD PRIOR TO FITMENT
PLACE THESE INSTRUCTIONS IN THE VEHICLES'S GLOVEBOX AFTER INSTALLATION IS COMPLETED

7. Remove 4 x Nuts on each side of the impact beam.

Discard the Impact Beam.

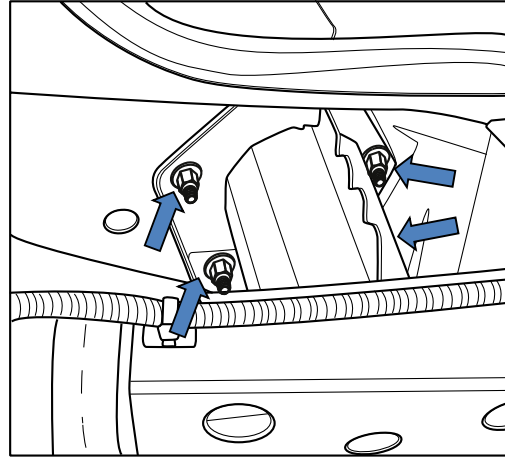

8. Unhook the two exhaust hangers for both LHS & RHS.

Remove 4x Screws retaining the LHS exhaust shield & set aside.

Repeat for RHS.

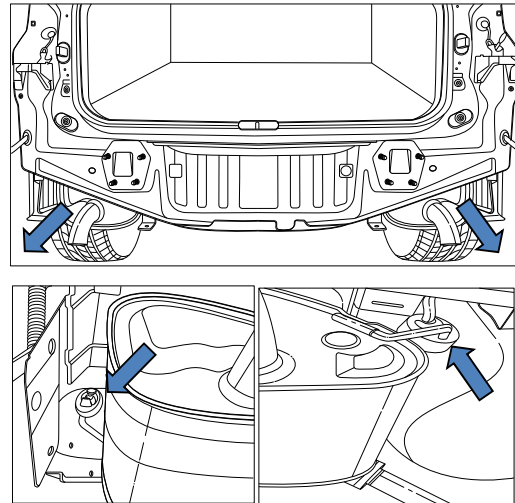

9. Offer the main Towbar assembly to the vehicle, via inserting the sidearms into the chassis rail.

Loosely secure each side with 3 x M12 Bolts and 3x M12 Flat Washers.

Tighten all Bolts to the following torque settings:

6 x M12 x 1.75P = 85Nm

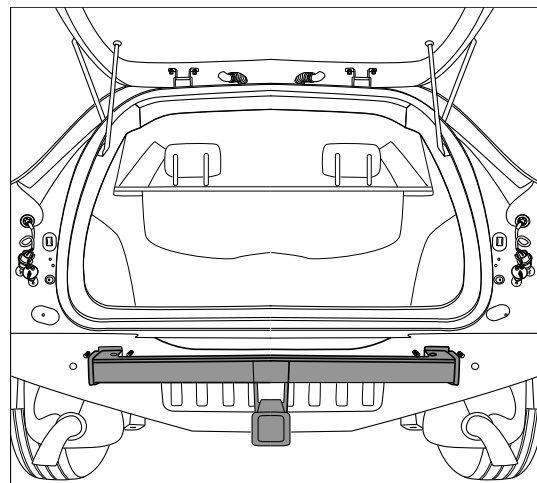

HAYMAN REESE
PART No: 03113RW
SUBARU OUTBACK/LIBERTY

INSTALLATION INSTRUCTIONS

PLEASE ENSURE THAT ALL INSTRUCTIONS ARE UNDERSTOOD PRIOR TO FITMENT
PLACE THESE INSTRUCTIONS IN THE VEHICLES'S GLOVEBOX AFTER INSTALLATION IS COMPLETED

- 10.** Perform the bumper cut out as shown in the following image by using the bumper cut template found on the final page of these instructions.

Centre the template on the lower edge of the bumper and cut out.

Re-fit bumper.

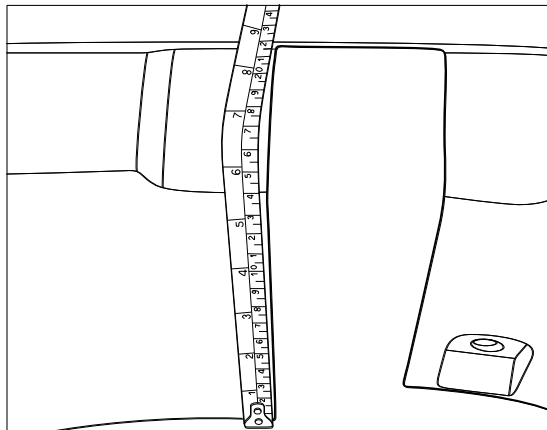

- 11.** Re-fit all removed parts and secure all fasteners, ensuring there are no squeaks or rattles.

Place the fitting instructions in the glove box after fitment.

INSTALLATION INSTRUCTIONS

PLEASE ENSURE THAT ALL INSTRUCTIONS ARE UNDERSTOOD PRIOR TO FITMENT
PLACE THESE INSTRUCTIONS IN THE VEHICLE'S GLOVEBOX AFTER INSTALLATION IS COMPLETED

SUBARU OUTBACK/LIBERTY BUMPER CUT TEMPLATE

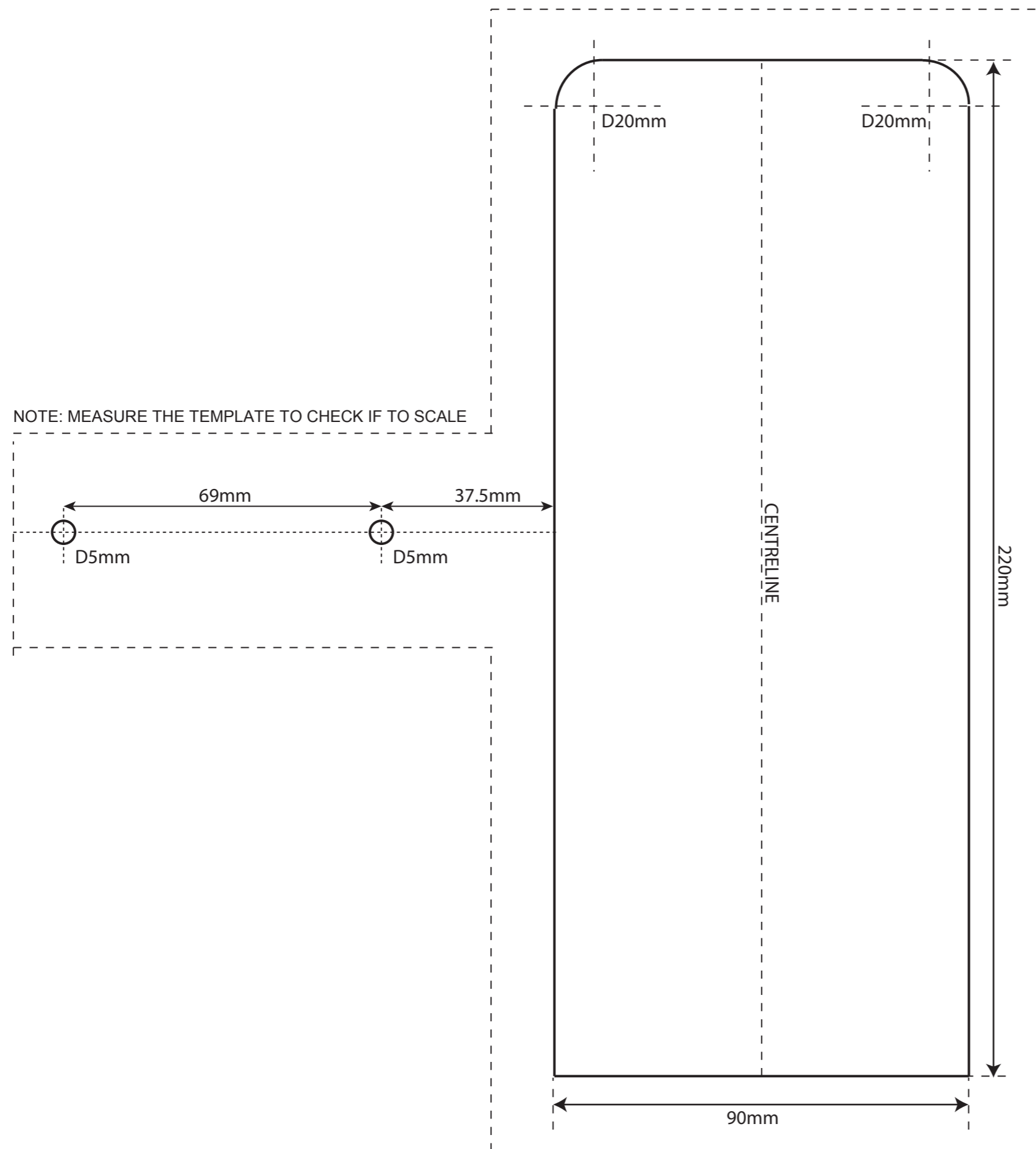

HAYMAN REESE

PART No: 100201-WL

SUBARU LIBERTY (SEDAN & WAGON), OUTBACK & FORESTER (2003 - 2012), SUBARU XV, IMPREZA (2007-2012),
IMPREZA (2012 - Onwards), FORESTER (2013 - Onwards), LIBERTY / OUTBACK WAGON (2015 - Onwards)

INSTALLATION INSTRUCTIONS

PLEASE ENSURE THAT INSTRUCTIONS ARE UNDERSTOOD PRIOR TO FITMENT

Wiring Loom Installation Instructions

**SUBARU LIBERTY (SEDAN & WAGON), OUTBACK
& FORESTER (2003 - 2012), SUBARU XV, IMPREZA (2007-2012),
IMPREZA (2012 - Onwards), FORESTER (2013 - Onwards),
LIBERTY / OUTBACK WAGON (2015 - Onwards)**

Part No: 100201-WL

Tail Length Required:

Liberty / Outback - 1200mm (Wagon)

Liberty - 1800mm (Sedan)

Forester - 1800mm

Subaru XV - 1200mm Open Tail Circuit: 04943

Subaru Impreza (2007-2012) - 1200mm

Subaru Impreza (2012 - Onwards) - 1200mm Open Tail Circuit: 04943

Forester (2013 - Onwards) - 1800mm Open Tail Circuit: 04943

**Liberty/Outback Wagon (2015 - Onwards) - 1200mm Open Tail Circuit:
04943**

Liberty Wagon & Outback - Page 2 - 5

Liberty Sedan - Page 6 - 8

Forester - Page 9 - 10

Subaru XV - Page 11 - 14

Subaru Impreza (2007 - 2012), Impreza (2012 - Onwards) - Page 15 - 18

Forester (2013 - Onwards) - Page 19 - 21

Liberty / Outback Wagon (2015 - Onwards) - Pages 22 - 24

Wiring Loom Installation Time: Approx. 25 minutes

Important



Due to possible vehicle variations, always confirm any noted vehicle colour wires with a multi-meter to ensure the correct function is identified before soldering or scotch locking.

Issue Date 25-02-15

Page 1

Part No: 100201-WL

Hayman Reese (Cequent)

PO Box 4050, Dandenong South VIC 3164

Phone 1800 812 017 Email info@haymanreese.com.au



www.haymanreese.com.au

HAYMAN REESE

PART No: 100201-WL

SUBARU LIBERTY (SEDAN & WAGON), OUTBACK & FORESTER (2003 - 2012), SUBARU XV, IMPREZA (2007-2012), IMPREZA (2012 - Onwards), FORESTER (2013 - Onwards), LIBERTY / OUTBACK WAGON (2015 - Onwards)

INSTALLATION INSTRUCTIONS

PLEASE ENSURE THAT INSTRUCTIONS ARE UNDERSTOOD PRIOR TO FITMENT

The following steps are for the Liberty Wagon & Outback models only. Refer to the front cover for other vehicle page locations.

1. In the luggage compartment area, remove the rear sun shade (1) and all floor trims (2).
2. Remove the LHS and RHS tail lights (3).
3. Remove the rear bumper fascia fasteners and the rear bumper fascia (4).

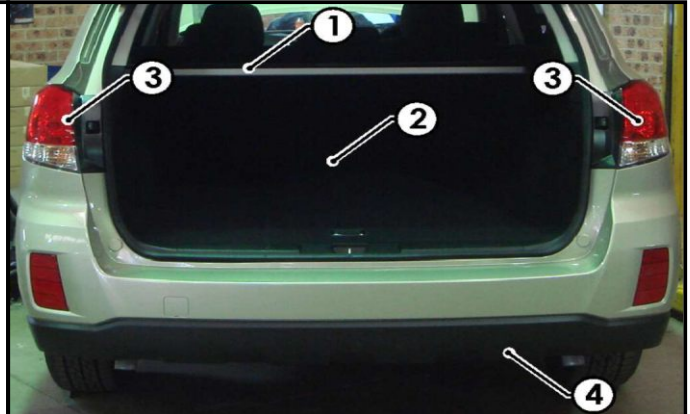

4. Remove the rear trim (1).

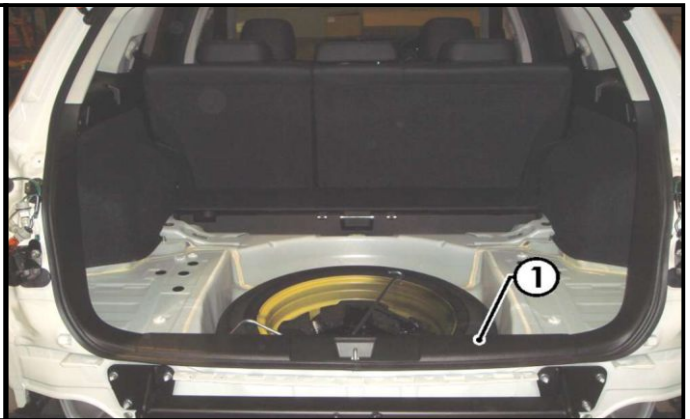

5. Remove the rear passenger seat cushion (1).

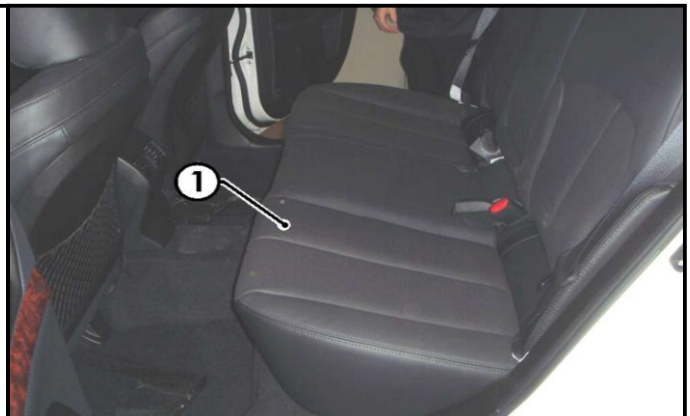

Issue Date 25-02-15

Page 2

Part No: 100201-WL

Hayman Reese (Cequent)
PO Box 4050, Dandenong South VIC 3164
Phone 1800 812 017 Email info@haymanreese.com.au

HAYMAN REESE

PART No: 100201-WL

SUBARU LIBERTY (SEDAN & WAGON), OUTBACK & FORESTER (2003 - 2012), SUBARU XV, IMPREZA (2007-2012), IMPREZA (2012 - Onwards), FORESTER (2013 - Onwards), LIBERTY / OUTBACK WAGON (2015 - Onwards)

INSTALLATION INSTRUCTIONS

PLEASE ENSURE THAT INSTRUCTIONS ARE UNDERSTOOD PRIOR TO FITMENT

6. Remove the LHS rear passenger sill trim (1).
7. Remove the two fasteners (2) from the LHS rear luggage compartment trim (3).

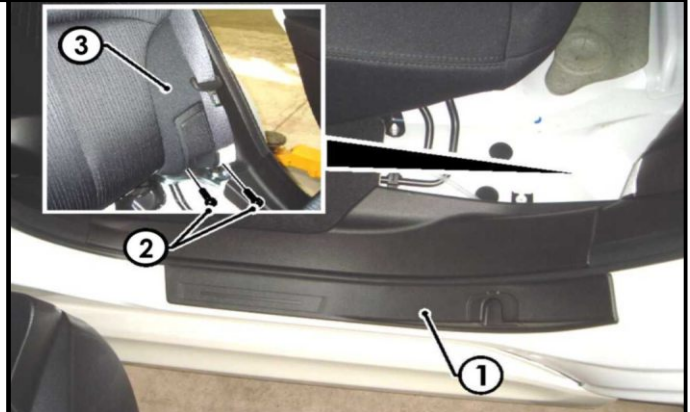

8. Remove the LHS luggage compartment trim fasteners (1) and then remove the LHS luggage compartment trim (2).

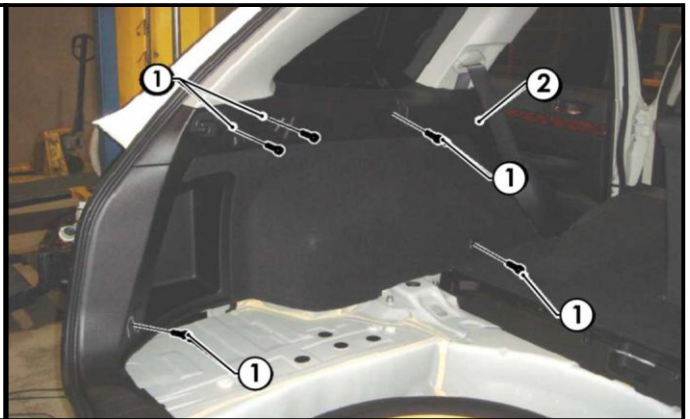

9. On the outer LHS rear quarter of the vehicle, locate and remove the grommet next to the vent. Widen the grommet hole (1) to Ø30mm using a step drill (2).
10. File any rough or sharp edges and spray on rust inhibitor.

Note: For vehicles fitted with sunroofs, drill a Ø2mm pilot hole in the area (3) below the sunroof drain. Drill out the hole to Ø30mm using a step drill. File any sharp or rough edges and spray on rust inhibitor.

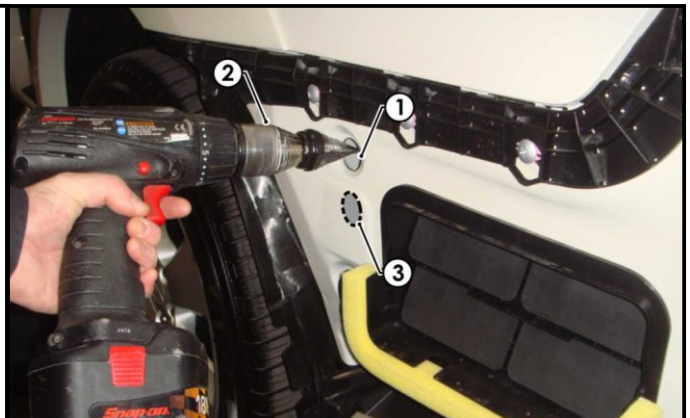

Issue Date 25-02-15

Page 3

Part No: 100201-WL

Hayman Reese (Cequent)
PO Box 4050, Dandenong South VIC 3164
Phone 1800 812 017 Email info@haymanreese.com.au

www.haymanreese.com.au



HAYMAN REESE

PART No: 100201-WL

SUBARU LIBERTY (SEDAN & WAGON), OUTBACK & FORESTER (2003 - 2012), SUBARU XV, IMPREZA (2007-2012), IMPREZA (2012 - Onwards), FORESTER (2013 - Onwards), LIBERTY / OUTBACK WAGON (2015 - Onwards)

INSTALLATION INSTRUCTIONS

PLEASE ENSURE THAT INSTRUCTIONS ARE UNDERSTOOD PRIOR TO FITMENT

11. Secure the tail harness socket (tail length 1200mm) (1) to the towbar mounting bracket using M4 fasteners (not supplied).



12. Route the tail harness (1) along the towbar and into the LHS rear quarter grommet.

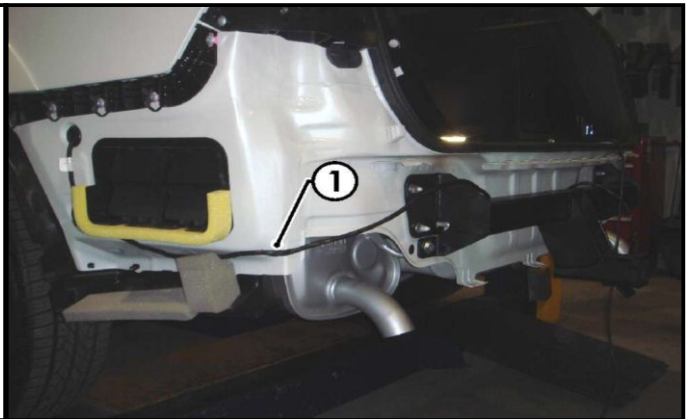

13. Inside the luggage compartment LHS, retrieve the tail harness (1) from the grommet hole (2) ensuring that the tail harness grommet is seated correctly.

14. Locate and free the vehicle 10-way female break out connector (3).

15. Connect the trailer patch (100201-WL) (4) to the tail harness (1).

16. Connect the trailer patch to the break out connector (3).

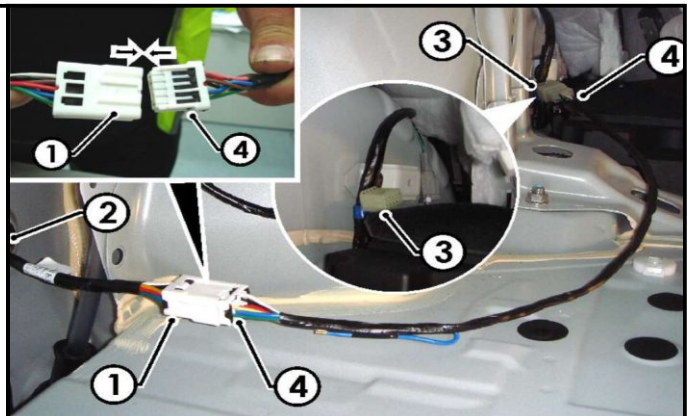

Issue Date 25-02-15

Page 4

Part No: 100201-WL

Hayman Reese (Cequent)
PO Box 4050, Dandenong South VIC 3164
Phone 1800 812 017 Email info@haymanreese.com.au

www.haymanreese.com.au



HAYMAN REESE

PART No: 100201-WL

SUBARU LIBERTY (SEDAN & WAGON), OUTBACK & FORESTER (2003 - 2012), SUBARU XV, IMPREZA (2007-2012), IMPREZA (2012 - Onwards), FORESTER (2013 - Onwards), LIBERTY / OUTBACK WAGON (2015 - Onwards)

INSTALLATION INSTRUCTIONS

PLEASE ENSURE THAT INSTRUCTIONS ARE UNDERSTOOD PRIOR TO FITMENT

17. Test the trailer wiring harness function using a Light Board or multimeter.
18. Secure all Harnesses using cables ties (not supplied).
19. Re-fit all removed parts and secure all fasteners, ensuring there are no squeaks or rattles.
20. Place the instructions in glove box after fitment.

Issue Date 25-02-15

Page 5

Part No: 100201-WL

Hayman Reese (Cequent)
PO Box 4050, Dandenong South VIC 3164
Phone 1800 812 017 Email info@haymanreese.com.au

www.haymanreese.com.au



HAYMAN REESE

PART No: 100201-WL

SUBARU LIBERTY (SEDAN & WAGON), OUTBACK & FORESTER (2003 - 2012), SUBARU XV, IMPREZA (2007-2012), IMPREZA (2012 - Onwards), FORESTER (2013 - Onwards), LIBERTY / OUTBACK WAGON (2015 - Onwards)

INSTALLATION INSTRUCTIONS

PLEASE ENSURE THAT INSTRUCTIONS ARE UNDERSTOOD PRIOR TO FITMENT

The following steps are for Liberty Sedan models only. Refer to the front cover for other vehicle page locations.

1. Remove the rear bumper from the vehicle.
2. Remove the luggage compartment floor carpet (1).

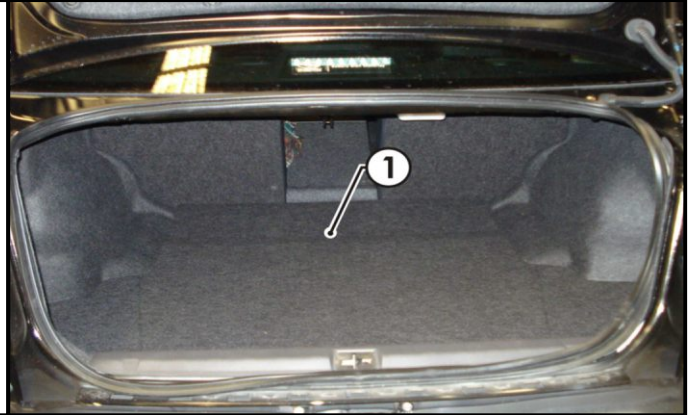

3. Remove the rear trim (1) by first removing the indicated fasteners (2).

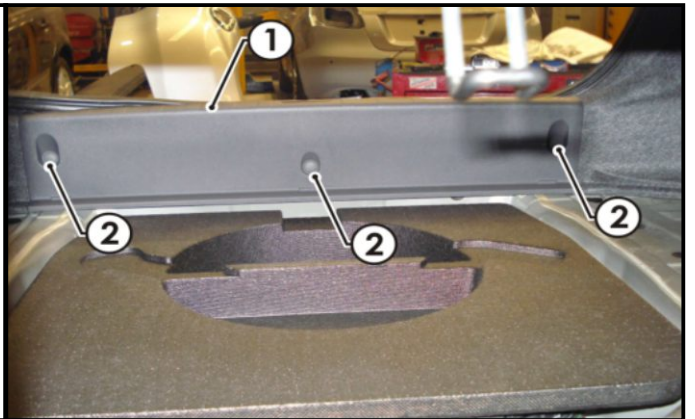

4. Remove the LHS luggage compartment trim (1) by first removing the two fasteners (2).

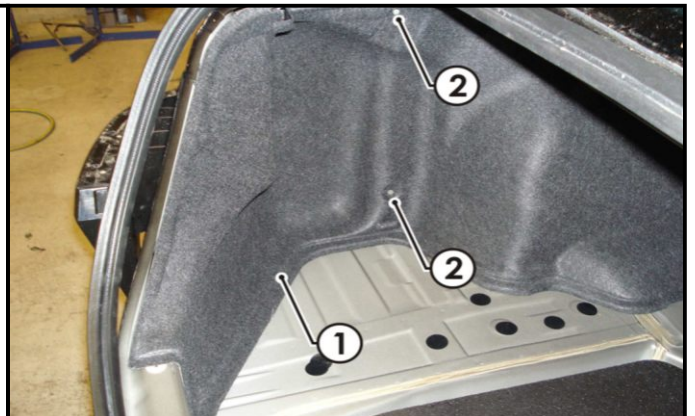

Issue Date 25-02-15

Page 6

Part No: 100201-WL

Hayman Reese (Cequent)
PO Box 4050, Dandenong South VIC 3164
Phone 1800 812 017 Email info@haymanreese.com.au

HAYMAN REESE

PART No: 100201-WL

SUBARU LIBERTY (SEDAN & WAGON), OUTBACK & FORESTER (2003 - 2012), SUBARU XV, IMPREZA (2007-2012), IMPREZA (2012 - Onwards), FORESTER (2013 - Onwards), LIBERTY / OUTBACK WAGON (2015 - Onwards)

INSTALLATION INSTRUCTIONS

PLEASE ENSURE THAT INSTRUCTIONS ARE UNDERSTOOD PRIOR TO FITMENT

5. On the outer LHS rear quarter of the vehicle, locate and remove the grommet next to the vent (in between the rear wheel arch and the vent). Widen the grommet hole (1) to $\text{\O}30\text{mm}$ using a step drill (2). File the grommet hole of any rough or sharp edges and spray on rust inhibitor.

Note: For vehicles fitted with sunroofs, drill a $\text{\O}2\text{mm}$ pilot hole in the area (3) below the sunroof drain. Drill out the hole to $\text{\O}30\text{mm}$ using a step drill. File any sharp or rough edges and spray on rust inhibitor.

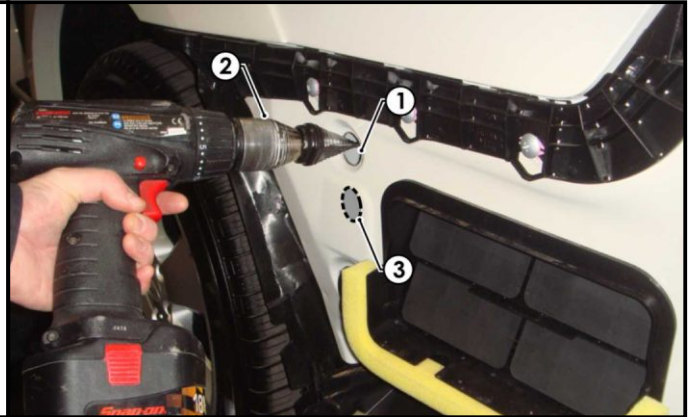

6. Secure the tail harness socket (tail length 1800mm) (1) to the towbar mounting bracket using M4 fasteners (not supplied).

This box was left blank intentionally.

7. Route the tail harness (1) along the towbar and into the LHS rear quarter grommet (2).

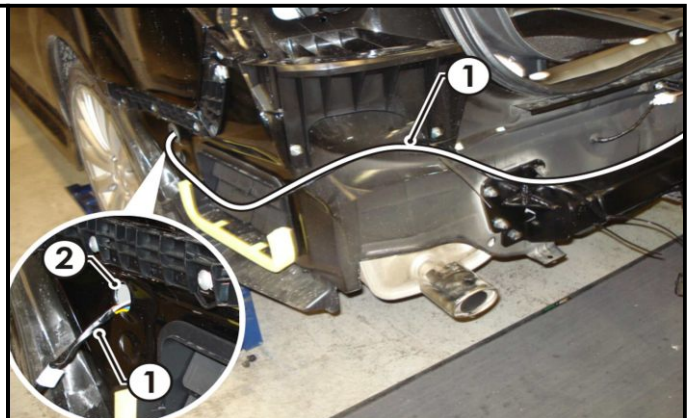

Issue Date 25-02-15

Page 7

Part No: 100201-WL

Hayman Reese (Cequent)
PO Box 4050, Dandenong South VIC 3164
Phone 1800 812 017 Email info@haymanreese.com.au

www.haymanreese.com.au



HAYMAN REESE

PART No: 100201-WL

SUBARU LIBERTY (SEDAN & WAGON), OUTBACK & FORESTER (2003 - 2012), SUBARU XV, IMPREZA (2007-2012), IMPREZA (2012 - Onwards), FORESTER (2013 - Onwards), LIBERTY / OUTBACK WAGON (2015 - Onwards)

INSTALLATION INSTRUCTIONS

PLEASE ENSURE THAT INSTRUCTIONS ARE UNDERSTOOD PRIOR TO FITMENT

8. Slide the tail harness grommet into the desired position, ensuring that it is seated correctly into the vehicle grommet hole. Secure with a cable tie (not supplied).
9. Connect the tail harness 10-way connector (1) into the trailer wiring harness (P/no: 100201-WL) 10-way mating connector (2).
10. Route the trailer patch towards the vehicle break out connector, located at the rear of the vehicle near the LHS of the wheel well.

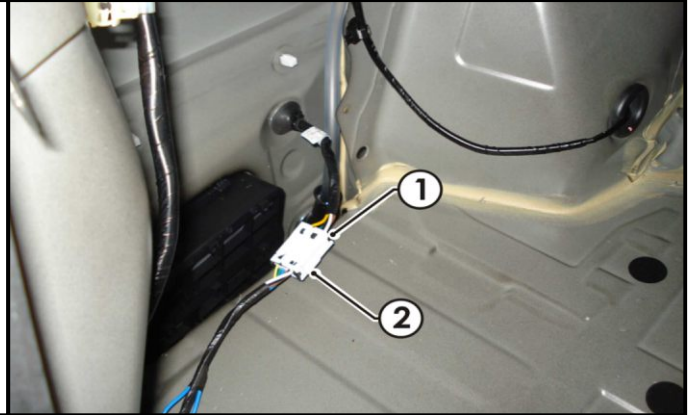

11. Connect the trailer patch (1) to the vehicle break out connector (2).
12. Re-fit the rear bumper fascia.
13. Secure all harnesses to the vehicle using cable ties (not supplied).
14. Test the trailer wiring harness function using a trailer light board or multimeter.
15. Re-fit all removed parts and secure all fasteners.
16. Place the instructions in the glove box after fitment.

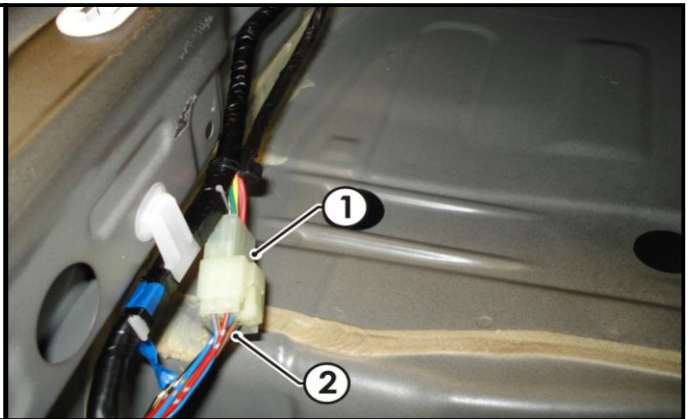

Issue Date 25-02-15

Page 8

Part No: 100201-WL

Hayman Reese (Cequent)
PO Box 4050, Dandenong South VIC 3164
Phone 1800 812 017 Email info@haymanreese.com.au

www.haymanreese.com.au



HAYMAN REESE

PART No: 100201-WL

SUBARU LIBERTY (SEDAN & WAGON), OUTBACK & FORESTER (2003 - 2012), SUBARU XV, IMPREZA (2007-2012), IMPREZA (2012 - Onwards), FORESTER (2013 - Onwards), LIBERTY / OUTBACK WAGON (2015 - Onwards)

INSTALLATION INSTRUCTIONS

PLEASE ENSURE THAT INSTRUCTIONS ARE UNDERSTOOD PRIOR TO FITMENT

The following steps are for Forester (2003 - 2012) models only. Refer to the front cover for other vehicle page locations.

1. In the LHS of the luggage compartment, remove the tool tray (1) by first removing the two clips (2).

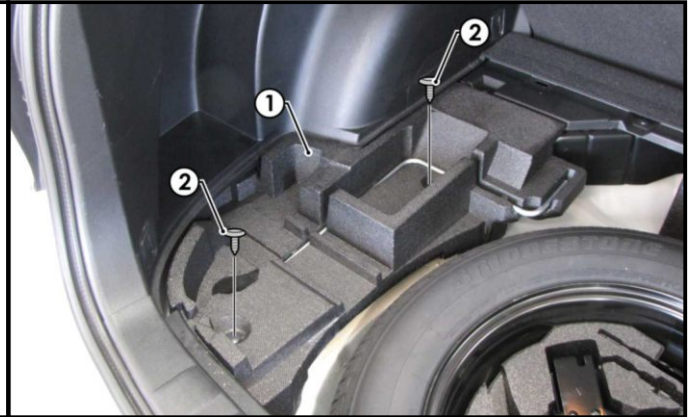

2. On the outer LHS rear quarter of the vehicle, locate and remove the grommet next to the vent. Widen the grommet hole (1) to Ø30mm using a step drill (2).
3. File any rough or sharp edges and spray on rust inhibitor.

Note: For vehicles fitted with sunroofs, drill a Ø2mm pilot hole in the area (3) below the sunroof drain. Drill out the hole to Ø30mm using a step drill. File any rough or sharp edges and spray on rust inhibitor.

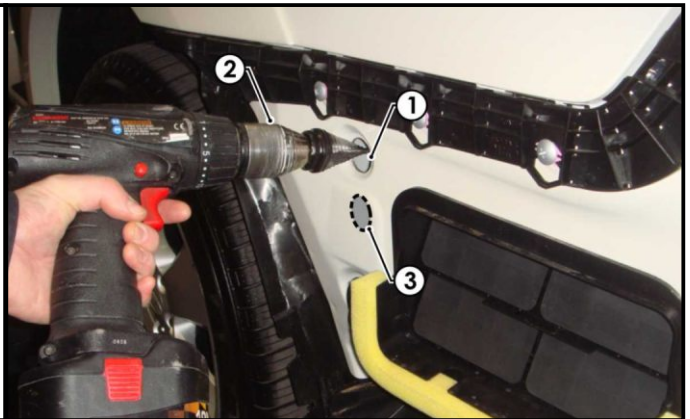

4. Secure the tail harness socket (tail length 1200mm) (1) to the towbar mounting bracket using M4 fasteners (not supplied).



Issue Date 25-02-15

Page 9

Part No: 100201-WL

Hayman Reese (Cequent)
PO Box 4050, Dandenong South VIC 3164
Phone 1800 812 017 Email info@haymanreese.com.au

www.haymanreese.com.au



HAYMAN REESE

PART No: 100201-WL

SUBARU LIBERTY (SEDAN & WAGON), OUTBACK & FORESTER (2003 - 2012), SUBARU XV, IMPREZA (2007-2012), IMPREZA (2012 - Onwards), FORESTER (2013 - Onwards), LIBERTY / OUTBACK WAGON (2015 - Onwards)

INSTALLATION INSTRUCTIONS

PLEASE ENSURE THAT INSTRUCTIONS ARE UNDERSTOOD PRIOR TO FITMENT

5. Route the tail harness (1) along the towbar and into the LHS rear quarter grommet.

This box was left blank intentionally.

6. Inside the LHS of the luggage compartment, retrieve the tail harness (1) from the grommet hole (2) ensuring that the tail harness grommet is seated correctly.
7. Locate and free the vehicle 10-way female break out connector (3).
8. Connect the trailer patch (100201-WL) (4) to the tail harness (1).
9. Connect the trailer patch to the break out connector (3).

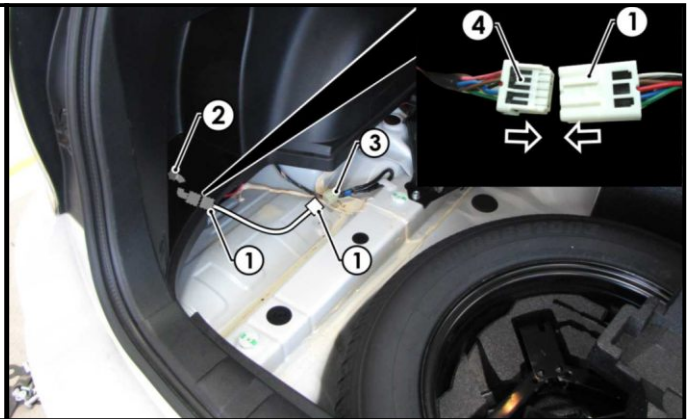

10. Test the trailer wiring harness function using a Light Board or multimeter.
11. Secure all harnesses using cables ties (not supplied).
12. Re-fit all removed parts and secure all fasteners, ensuring there are no squeaks or rattles.
13. Place the instructions in glove box after fitment.

This box was left blank intentionally.

Issue Date 25-02-15

Page 10

Part No: 100201-WL

Hayman Reese (Cequent)
PO Box 4050, Dandenong South VIC 3164
Phone 1800 812 017 Email info@haymanreese.com.au

www.haymanreese.com.au



HAYMAN REESE

PART No: 100201-WL

SUBARU LIBERTY (SEDAN & WAGON), OUTBACK & FORESTER (2003 - 2012), SUBARU XV, IMPREZA (2007-2012),
IMPREZA (2012 - Onwards), FORESTER (2013 - Onwards), LIBERTY / OUTBACK WAGON (2015 - Onwards)

INSTALLATION INSTRUCTIONS

PLEASE ENSURE THAT INSTRUCTIONS ARE UNDERSTOOD PRIOR TO FITMENT

The following steps are for Subaru XV models only. Refer to the front cover for other vehicle page locations.

1. In the luggage compartment, remove the floor carpet cover (1) and the parcel shelf (2).



2. Remove the two luggage compartment storage trays (1) by first removing the clips (2).

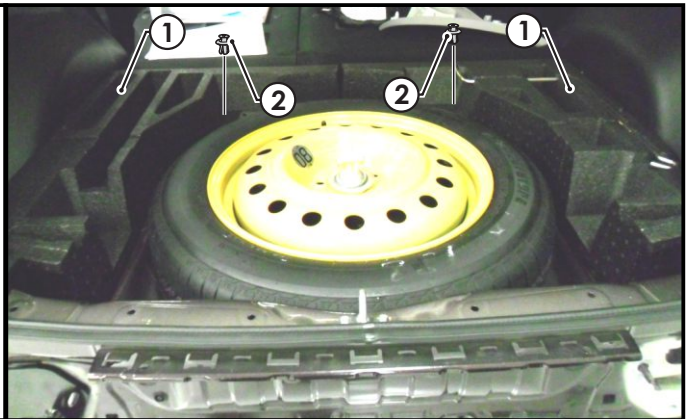

3. Remove the rear luggage compartment trim (1) by first removing the two clips (2) and pulling in an upwards direction.

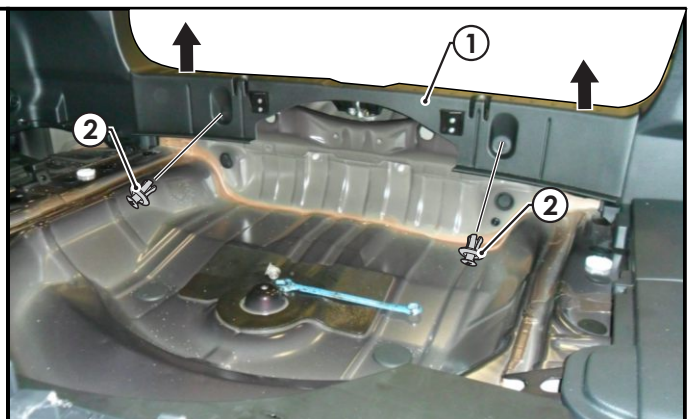

Issue Date 25-02-15

Page 11

Part No: 100201-WL

Hayman Reese (Cequent)
PO Box 4050, Dandenong South VIC 3164
Phone 1800 812 017 Email info@haymanreese.com.au

www.haymanreese.com.au



HAYMAN REESE

PART No: 100201-WL

SUBARU LIBERTY (SEDAN & WAGON), OUTBACK & FORESTER (2003 - 2012), SUBARU XV, IMPREZA (2007-2012), IMPREZA (2012 - Onwards), FORESTER (2013 - Onwards), LIBERTY / OUTBACK WAGON (2015 - Onwards)

INSTALLATION INSTRUCTIONS

PLEASE ENSURE THAT INSTRUCTIONS ARE UNDERSTOOD PRIOR TO FITMENT

4. Remove the LHS upper 'C' pillar trim (1) by releasing the screw (2).

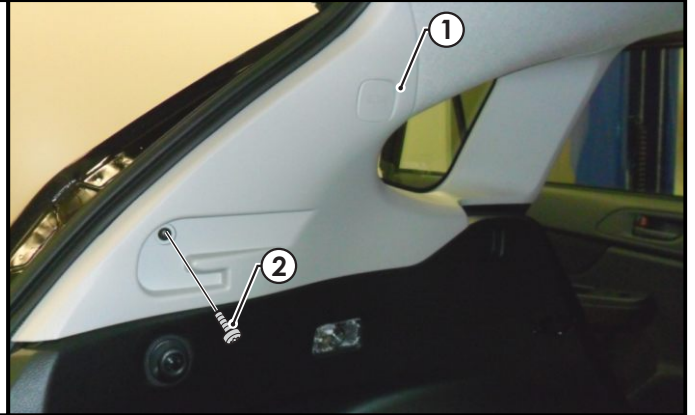

5. Dislodge the LHS luggage compartment trim (1) by removing the two screws (2).

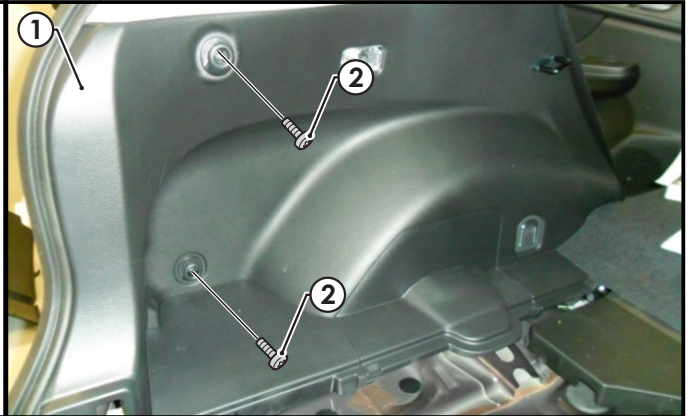

6. On the LHS rear quarter panel, connect the trailer patch (100201-WL) connector (1) to the vehicle break out connector (2).

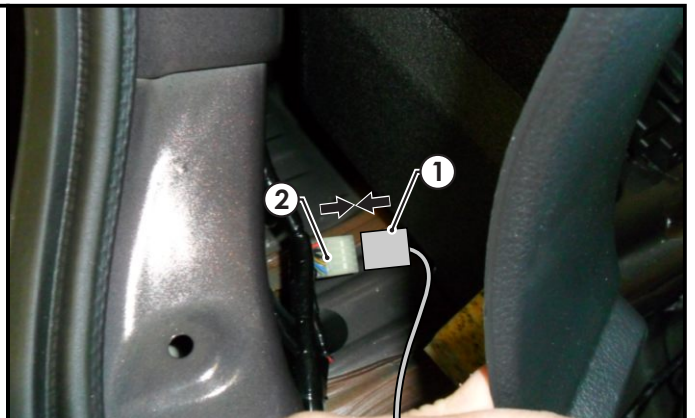

Issue Date 25-02-15

Page 12

Part No: 100201-WL

Hayman Reese (Cequent)
PO Box 4050, Dandenong South VIC 3164
Phone 1800 812 017 Email info@haymanreese.com.au

www.haymanreese.com.au



HAYMAN REESE

PART No: 100201-WL

SUBARU LIBERTY (SEDAN & WAGON), OUTBACK & FORESTER (2003 - 2012), SUBARU XV, IMPREZA (2007-2012), IMPREZA (2012 - Onwards), FORESTER (2013 - Onwards), LIBERTY / OUTBACK WAGON (2015 - Onwards)

INSTALLATION INSTRUCTIONS

PLEASE ENSURE THAT INSTRUCTIONS ARE UNDERSTOOD PRIOR TO FITMENT

7. To enable the RPA cutout, splice to the loose GREY/BLACK wire from the tail harness into Pin 1 of the connector (1).

8. On the tail harness splice the GREY wire (2) back into any ground wire of the harness (3).

Note: Due to possible vehicle variations, always confirm vehicle harness wires using a multi-meter.

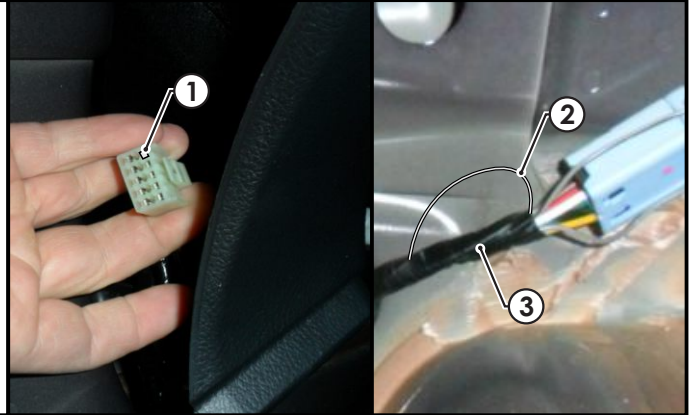

9. Route the trailer patch (1) along the rear luggage compartment, towards the existing vehicle grommet (2) as shown.

Note: If vehicle grommet is occupied as sunroof drainage, drill a Ø30mm hole in the location shown (3).

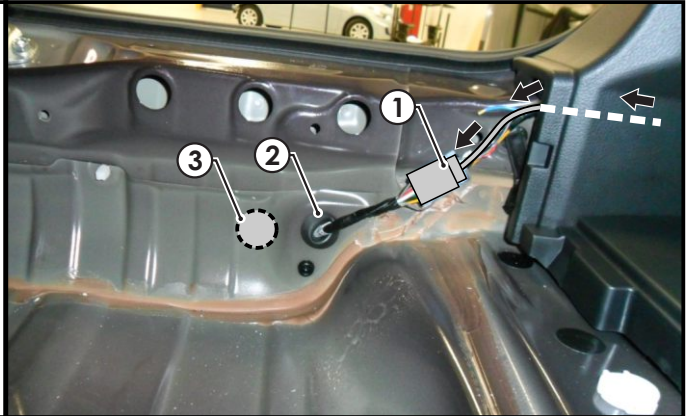

10. Mount the trailer socket (1) to the tow bar mounting bracket using M4 fasteners (not supplied).

11. Route the tail harness (2) across the tow bar towards the LHS of the vehicle and up through the previously drilled out hole.

12. Ensure the tail harness grommet is seated correctly and secure in place using a cable tie (not supplied).

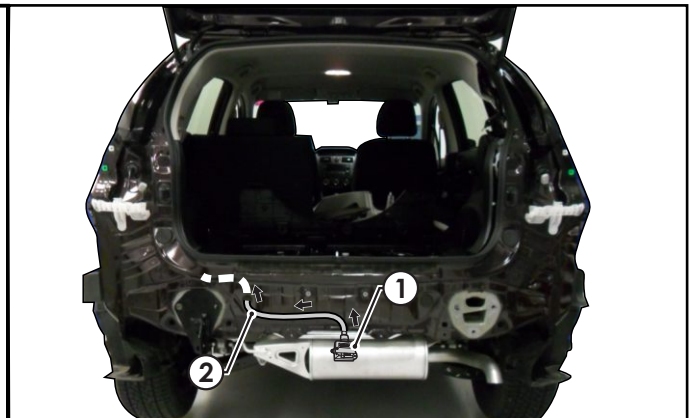

Issue Date 25-02-15

Page 13

Part No: 100201-WL

Hayman Reese (Cequent)

PO Box 4050, Dandenong South VIC 3164

Phone 1800 812 017 Email info@haymanreese.com.au

HAYMAN REESE

PART No: 100201-WL

SUBARU LIBERTY (SEDAN & WAGON), OUTBACK & FORESTER (2003 - 2012), SUBARU XV, IMPREZA (2007-2012), IMPREZA (2012 - Onwards), FORESTER (2013 - Onwards), LIBERTY / OUTBACK WAGON (2015 - Onwards)

INSTALLATION INSTRUCTIONS

PLEASE ENSURE THAT INSTRUCTIONS ARE UNDERSTOOD PRIOR TO FITMENT

13. Connect the tail harness (tail length 1200mm) 8-way connector (1) to the trailer patch mating 8-way connector (2).

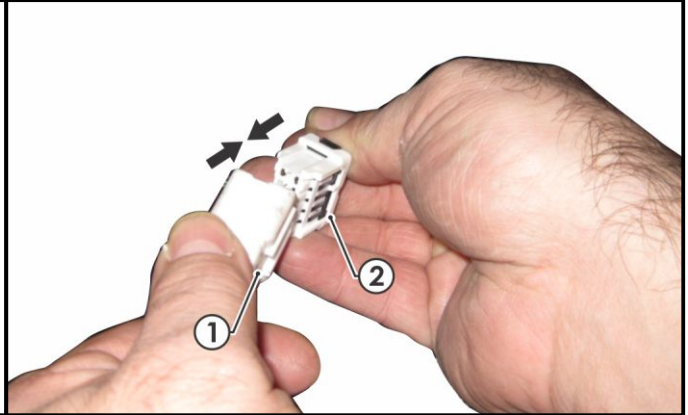

14. Test the trailer wiring harness function using a light board or multi meter.
15. Secure all harnesses using cable ties (not supplied).
16. Re-fit all removed parts and secure all fasteners, ensuring there are no squeaks or rattles.
17. Place the fitting instructions in the glove box after fitment.

Issue Date 25-02-15

Page 14

Part No: 100201-WL

Hayman Reese (Cequent)
PO Box 4050, Dandenong South VIC 3164
Phone 1800 812 017 Email info@haymanreese.com.au

www.haymanreese.com.au



HAYMAN REESE

PART No: 100201-WL

SUBARU LIBERTY (SEDAN & WAGON), OUTBACK & FORESTER (2003 - 2012), SUBARU XV, IMPREZA (2007-2012), IMPREZA (2012 - Onwards), FORESTER (2013 - Onwards), LIBERTY / OUTBACK WAGON (2015 - Onwards)

INSTALLATION INSTRUCTIONS

PLEASE ENSURE THAT INSTRUCTIONS ARE UNDERSTOOD PRIOR TO FITMENT

The following steps are for Subaru Impreza (2007 - 2012) & Impreza (2012 - Onwards) models only. Refer to the front cover for other vehicle page locations.

1. Inside the luggage compartment, remove the floor carpet cover (1).



2. Remove the rear luggage compartment trim (1) by first releasing the three fasteners (2).

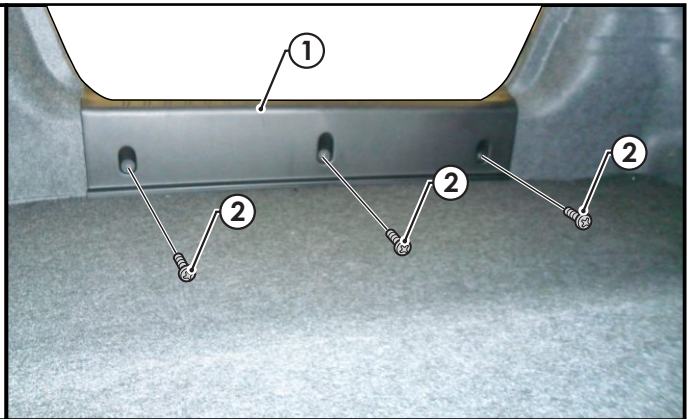

3. On the LHS of the luggage compartment, remove the foam support cover (1).

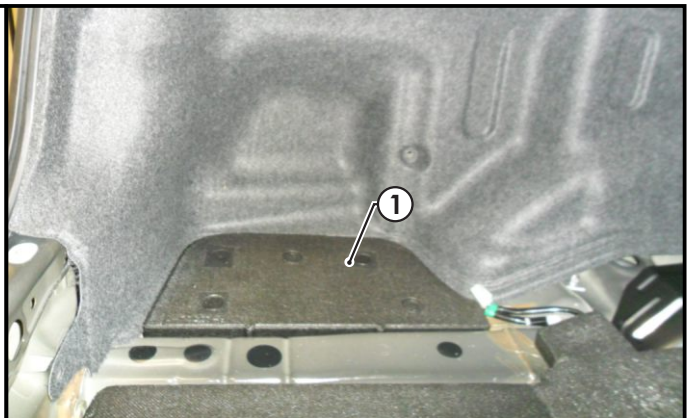

Issue Date 25-02-15

Page 15

Part No: 100201-WL

Hayman Reese (Cequent)
PO Box 4050, Dandenong South VIC 3164
Phone 1800 812 017 Email info@haymanreese.com.au

www.haymanreese.com.au



HAYMAN REESE

PART No: 100201-WL

SUBARU LIBERTY (SEDAN & WAGON), OUTBACK & FORESTER (2003 - 2012), SUBARU XV, IMPREZA (2007-2012), IMPREZA (2012 - Onwards), FORESTER (2013 - Onwards), LIBERTY / OUTBACK WAGON (2015 - Onwards)

INSTALLATION INSTRUCTIONS

PLEASE ENSURE THAT INSTRUCTIONS ARE UNDERSTOOD PRIOR TO FITMENT

The following Steps 4 - 6 are for Impreza (2012 - Onwards) models only.

4. Remove the three clips (1) and then remove the LHS luggage compartment trim (2).

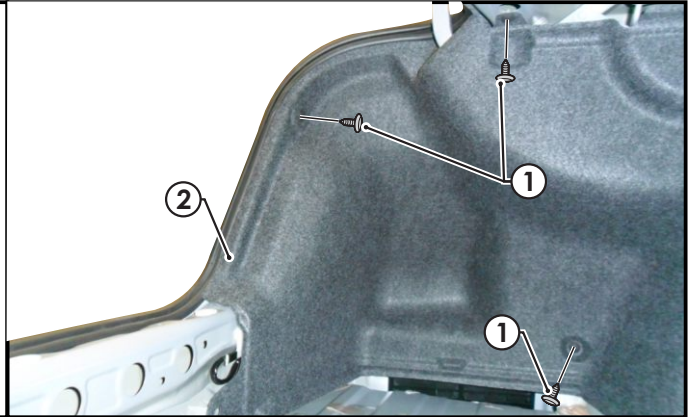

5. To enable the RPA cutout, splice the loose GREY/BLACK wire from the tail harness to the PIN 1 (PURPLE wire) of the connector (1).

6. On the tail harness splice the GREY wire (2) back into any ground wire of the harness (3).

Note: Due to possible vehicle variations, always confirm vehicle harness wires using a multi-meter.

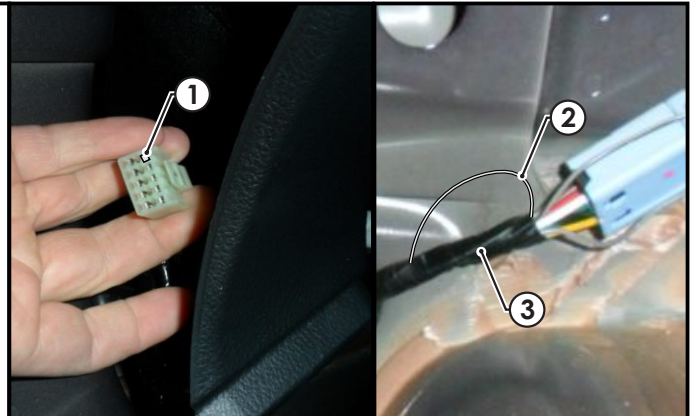

7. On the RHS rear wheel well, remove the blanking grommet (1) and drill the hole out to Ø30mm.

8. File any rough or sharp edges and spray with rust inhibitor.

Note: If the grommet is occupied drill a Ø30mm hole (2) next to the occupied grommet.

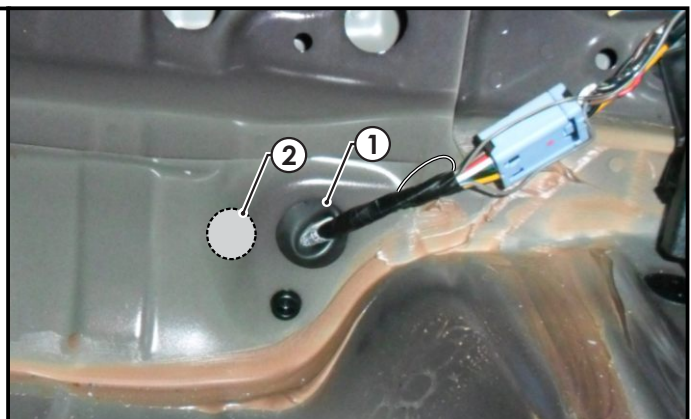

Issue Date 25-02-15

Page 16

Part No: 100201-WL

Hayman Reese (Cequent)

PO Box 4050, Dandenong South VIC 3164

Phone 1800 812 017 Email info@haymanreese.com.au

www.haymanreese.com.au



HAYMAN REESE

PART No: 100201-WL

SUBARU LIBERTY (SEDAN & WAGON), OUTBACK & FORESTER (2003 - 2012), SUBARU XV, IMPREZA (2007-2012), IMPREZA (2012 - Onwards), FORESTER (2013 - Onwards), LIBERTY / OUTBACK WAGON (2015 - Onwards)

INSTALLATION INSTRUCTIONS

PLEASE ENSURE THAT INSTRUCTIONS ARE UNDERSTOOD PRIOR TO FITMENT

The following Steps 9 - 11 are for Impreza (2007 - 2012) models only.

9. Locate the vehicle break out connector (1) in the LHS of the rear quarter panel.
10. Connect the trailer patch (P/No: 100201-WL) connector (2) to the vehicle's break out connector (1).
11. Route the trailer patch (3) towards the rear vehicle grommet (4).

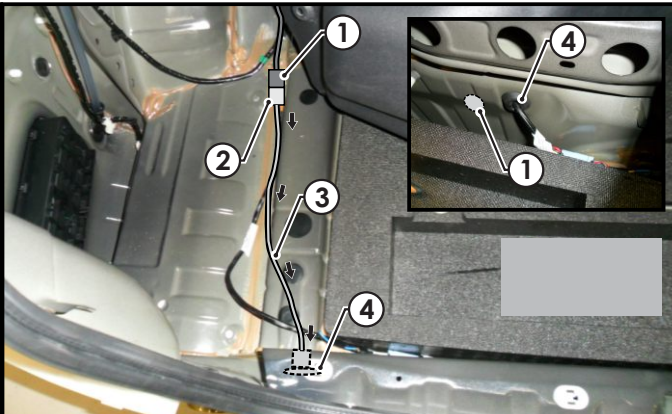

The following Steps 12 - 14 are for Impreza (2012 - Onwards) models only.

12. Locate the vehicle break out connector (1) on the LHS of the rear quarter panel.
13. Connect the trailer patch (P/No: 100201-WL) connector (2) to the vehicle's break out connector (1).
14. Route the trailer patch (3) towards the rear vehicle grommet (4).

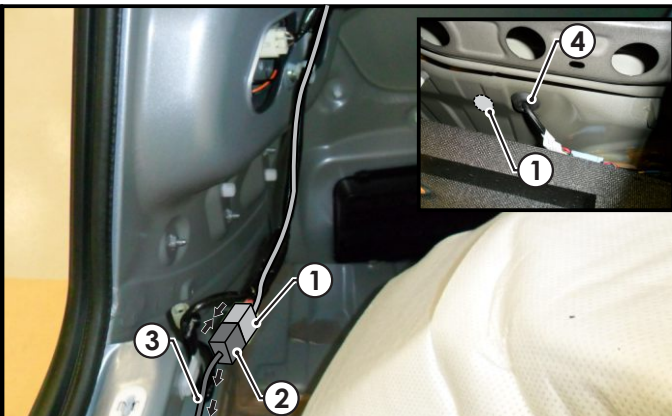

15. Mount the trailer socket (1) to the tow bar mounting bracket using M4 fasteners (not supplied).
16. Route the tail harness (2) across the tow bar towards the LHS of the vehicle and up through the previously drilled out hole.
17. Ensure the tail harness grommet is seated correctly and secure in place using a cable tie (not supplied).



Issue Date 25-02-15

Page 17

Part No: 100201-WL

Hayman Reese (Cequent)

PO Box 4050, Dandenong South VIC 3164

Phone 1800 812 017 Email info@haymanreese.com.au

HAYMAN REESE

PART No: 100201-WL

SUBARU LIBERTY (SEDAN & WAGON), OUTBACK & FORESTER (2003 - 2012), SUBARU XV, IMPREZA (2007-2012),
IMPREZA (2012 - Onwards), FORESTER (2013 - Onwards), LIBERTY / OUTBACK WAGON (2015 - Onwards)

INSTALLATION INSTRUCTIONS

PLEASE ENSURE THAT INSTRUCTIONS ARE UNDERSTOOD PRIOR TO FITMENT

18. Connect the tail harness (tail length 1200mm) 8-way connector (1) to the trailer patch mating 8-way connector (2).

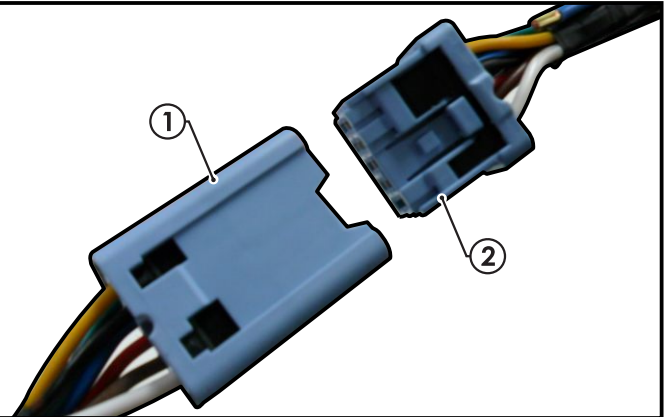

19. Test the trailer wiring harness function using a light board or multi meter.
20. Secure all harnesses using cable ties (not supplied).
21. Re-fit all removed parts and secure all fasteners, ensuring there are no squeaks or rattles.
22. Place the fitting instructions in the glove box after fitment.

Issue Date 25-02-15

Page 18

Part No: 100201-WL

Hayman Reese (Cequent)
PO Box 4050, Dandenong South VIC 3164
Phone 1800 812 017 Email info@haymanreese.com.au

www.haymanreese.com.au



HAYMAN REESE

PART No: 100201-WL

SUBARU LIBERTY (SEDAN & WAGON), OUTBACK & FORESTER (2003 - 2012), SUBARU XV, IMPREZA (2007-2012), IMPREZA (2012 - Onwards), FORESTER (2013 - Onwards), LIBERTY / OUTBACK WAGON (2015 - Onwards)

INSTALLATION INSTRUCTIONS

PLEASE ENSURE THAT INSTRUCTIONS ARE UNDERSTOOD PRIOR TO FITMENT

The following steps are for Forester (2013 - Onwards). Refer to the front cover for other vehicle page locations.

1. In the luggage compartment, remove the floor carpet cover (1).
2. Remove both the LHS & RHS trim covers (2).

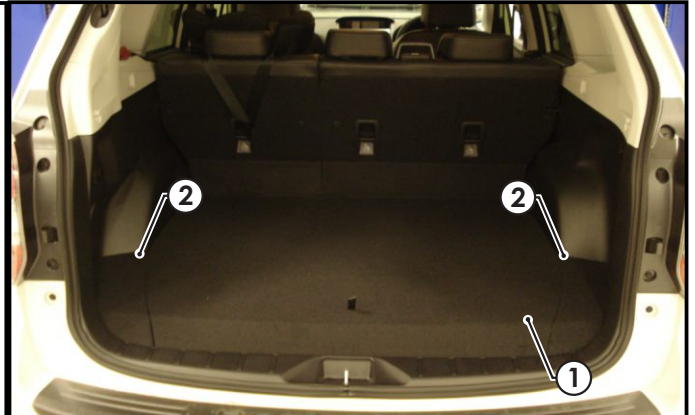

3. Remove the LHS foam support (1) by first removing the two clips (2).

Repeat for the RHS.



4. Remove the rear luggage compartment trim (1) by pulling in an upwards direction.



Issue Date 25-02-15

Page 19

Part No: 100201-WL

Hayman Reese (Cequent)
PO Box 4050, Dandenong South VIC 3164
Phone 1800 812 017 Email info@haymanreese.com.au

www.haymanreese.com.au



HAYMAN REESE

PART No: 100201-WL

SUBARU LIBERTY (SEDAN & WAGON), OUTBACK & FORESTER (2003 - 2012), SUBARU XV, IMPREZA (2007-2012), IMPREZA (2012 - Onwards), FORESTER (2013 - Onwards), LIBERTY / OUTBACK WAGON (2015 - Onwards)

INSTALLATION INSTRUCTIONS

PLEASE ENSURE THAT INSTRUCTIONS ARE UNDERSTOOD PRIOR TO FITMENT

5. Fold the rear passenger seats (1) forward.
6. Unclip the rear seat cover (2).
7. Remove the rear passenger seat trim (3) by first removing the seven clips (4).

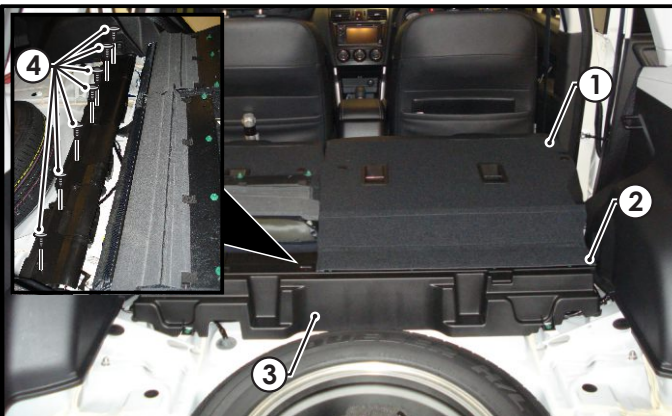

8. On the LHS of the luggage compartment (1), remove the three fasteners (2).
9. Dislodge the LHS luggage compartment trim (1).

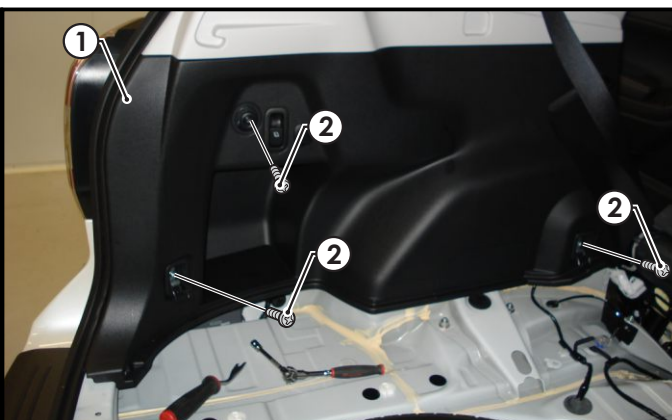

10. Locate the LHS break out connector (1).
11. Connect the trailer patch (P/No: 100201-WL) connector (2) to the vehicle's break out connector (1).
12. Route the trailer patch (3) towards the existing vehicle grommet (4).

Note: If existing vehicle grommet is occupied, drill a Ø30mm hole next to it. File any rough or sharp edges and spray rust inhibitor.

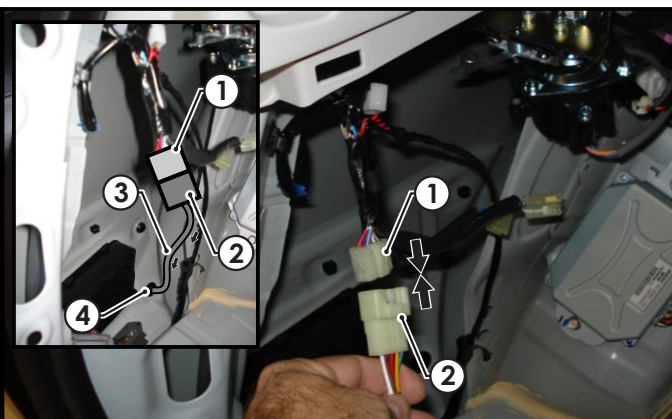

Issue Date 25-02-15

Page 20

Part No: 100201-WL

Hayman Reese (Cequent)
PO Box 4050, Dandenong South VIC 3164
Phone 1800 812 017 Email info@haymanreese.com.au

www.haymanreese.com.au



HAYMAN REESE

PART No: 100201-WL

SUBARU LIBERTY (SEDAN & WAGON), OUTBACK & FORESTER (2003 - 2012), SUBARU XV, IMPREZA (2007-2012), IMPREZA (2012 - Onwards), FORESTER (2013 - Onwards), LIBERTY / OUTBACK WAGON (2015 - Onwards)

INSTALLATION INSTRUCTIONS

PLEASE ENSURE THAT INSTRUCTIONS ARE UNDERSTOOD PRIOR TO FITMENT

13. Mount the trailer socket (1) to the tow bar mounting bracket using M4 fasteners (not supplied).
14. Route the tail harness (2) across the tow bar towards the LHS of the vehicle and up through the grommet hole.
15. Ensure the tail harness grommet is seated correctly and secure in place using a cable tie (not supplied).



16. Connect the tail harness (tail length 1800mm) 8-way connector (1) to the trailer patch mating 8-way connector (2).

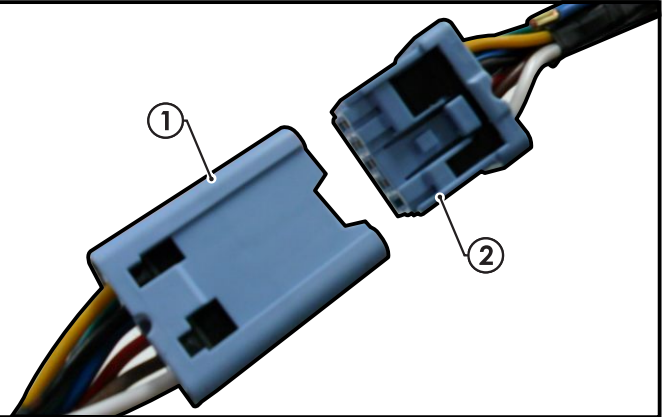

17. Test the trailer wiring harness function using a light board or multi meter.
18. Secure all harnesses using cable ties (not supplied).
19. Re-fit all removed parts and secure all fasteners, ensuring there are no squeaks or rattles.
20. Place the fitting instructions in the glove box after fitment.

Issue Date 25-02-15

Page 21

Part No: 100201-WL

Hayman Reese (Cequent)
PO Box 4050, Dandenong South VIC 3164
Phone 1800 812 017 Email info@haymanreese.com.au

www.haymanreese.com.au



HAYMAN REESE

PART No: 100201-WL

SUBARU LIBERTY (SEDAN & WAGON), OUTBACK & FORESTER (2003 - 2012), SUBARU XV, IMPREZA (2007-2012), IMPREZA (2012 - Onwards), FORESTER (2013 - Onwards), LIBERTY / OUTBACK WAGON (2015 - Onwards)

INSTALLATION INSTRUCTIONS

PLEASE ENSURE THAT INSTRUCTIONS ARE UNDERSTOOD PRIOR TO FITMENT

The following steps are for Liberty/Outback Wagon (2015 - Onwards). Refer to the front cover for other vehicle page locations.

1. In the luggage compartment, remove the rear parcel shelf (1).
2. Remove the rubber floor cover (2) if fitted.

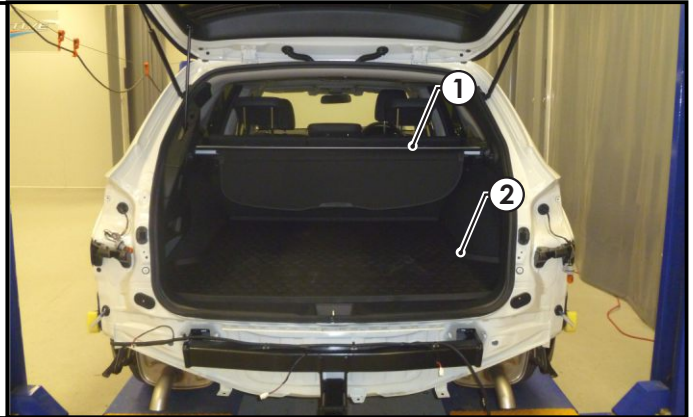

3. Remove the spare wheel cover (1).
4. Fold down the LHS rear seat (2).



5. On the LHS of the luggage compartment (1), remove the fasteners from underneath the indicated latches (2).
6. Dislodge the LHS luggage compartment trim (1).

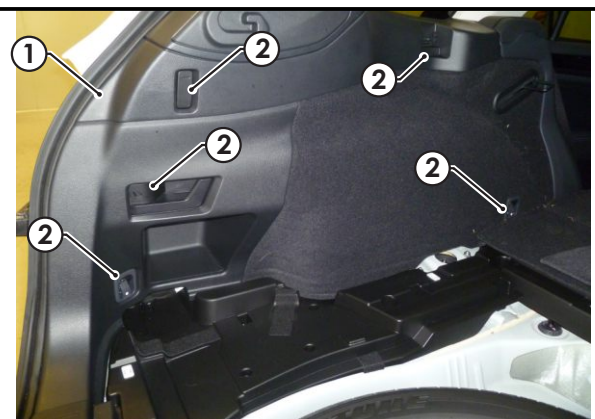

Issue Date 25-02-15

Page 22

Part No: 100201-WL

Hayman Reese (Cequent)
PO Box 4050, Dandenong South VIC 3164
Phone 1800 812 017 Email info@haymanreese.com.au

HAYMAN REESE

PART No: 100201-WL

SUBARU LIBERTY (SEDAN & WAGON), OUTBACK & FORESTER (2003 - 2012), SUBARU XV, IMPREZA (2007-2012), IMPREZA (2012 - Onwards), FORESTER (2013 - Onwards), LIBERTY / OUTBACK WAGON (2015 - Onwards)

INSTALLATION INSTRUCTIONS

PLEASE ENSURE THAT INSTRUCTIONS ARE UNDERSTOOD PRIOR TO FITMENT

7. On the rear of the vehicle exterior, drill a Ø30mm hole into the vehicle sheet metal (1).
8. File down any rough or sharp edges and apply rust inhibitor (not supplied).

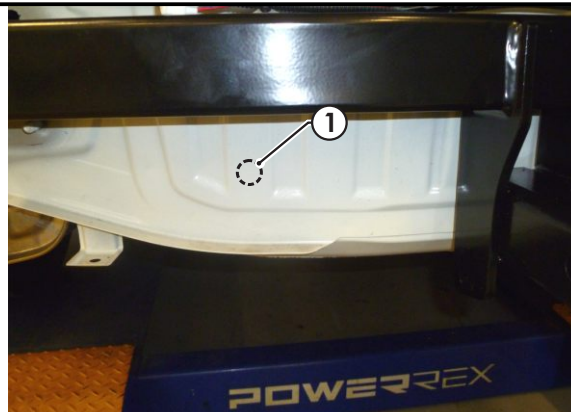

9. Mount the trailer socket (1) to the rear bumper via the tow bar mounting bracket (supplied with the towbar kit) using M4 fasteners (not supplied).
10. Route the tail harness (tail length: 1200mm) (2) towards the LHS of the vehicle and up through the grommet hole (3).



11. Connect the trailer patch (P/No: 100201-WL) (1) to the vehicle break-out connector (2).
12. Connect the trailer patch tail connector (3) to the tail harness connector (4).
13. At the vehicle exterior, ensure the tail harness grommet is seated correctly and secured into place using a cable tie (not supplied).

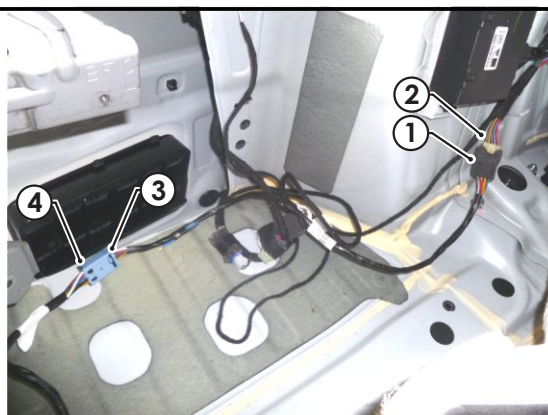

Issue Date 25-02-15

Page 23

Part No: 100201-WL

Hayman Reese (Cequent)

PO Box 4050, Dandenong South VIC 3164

Phone 1800 812 017 Email info@haymanreese.com.au

HAYMAN REESE

PART No: 100201-WL

SUBARU LIBERTY (SEDAN & WAGON), OUTBACK & FORESTER (2003 - 2012), SUBARU XV, IMPREZA (2007-2012), IMPREZA (2012 - Onwards), FORESTER (2013 - Onwards), LIBERTY / OUTBACK WAGON (2015 - Onwards)

INSTALLATION INSTRUCTIONS

PLEASE ENSURE THAT INSTRUCTIONS ARE UNDERSTOOD PRIOR TO FITMENT

14. To enable the ISS (Intelligent Start Stop) cutout, splice the loose GREY/BLACK wire from the tail harness to the PIN 1 (GREY wire) of the connector (1).

15. On the tail harness splice the GREY wire (2) back into a ground wire of the harness (3).

Note: Due to possible vehicle variations, always confirm vehicle harness wires using a multi-meter.

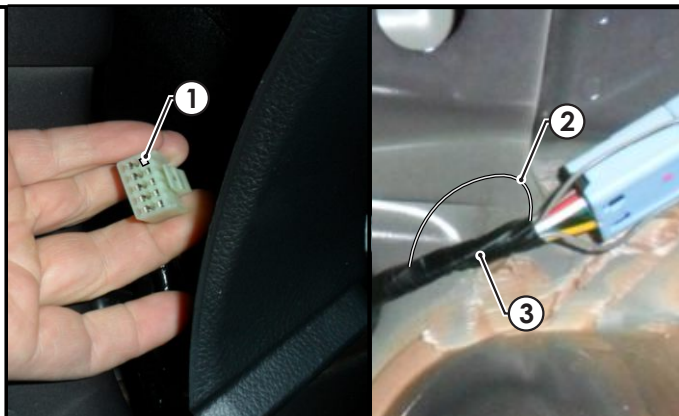

16. Test the trailer wiring harness function using a light board or multi meter.

17. Secure all harnesses using cable ties (not supplied).

18. Re-fit all removed parts and secure all fasteners, ensuring there are no squeaks or rattles.

19. Place the fitting instructions in the glove box after fitment.

Issue Date 25-02-15

Page 24

Part No: 100201-WL

Hayman Reese (Cequent)

PO Box 4050, Dandenong South VIC 3164

Phone 1800 812 017 Email info@haymanreese.com.au

www.haymanreese.com.au





FITTING INSTRUCTIONS

Smart Pin (55070BL)

• These fitting instructions are supplied to ensure understanding of how the SMART PIN should be fitted and used correctly.

• Once installed, we recommend **ALL** instructions are kept and placed in the vehicle glove box.

NOTE: Routine maintenance and inspection of the towbar & SMART PIN is required. Regularly inspect for wear and check the tightness of the SMART PIN NUT. Follow instructions below to retighten the nut when necessary.

***Do not tow with your vehicle if the R CLIP or the SMART PIN NUT is loose or missing. Replacement parts are available from your Hayman Reese Distributor.**

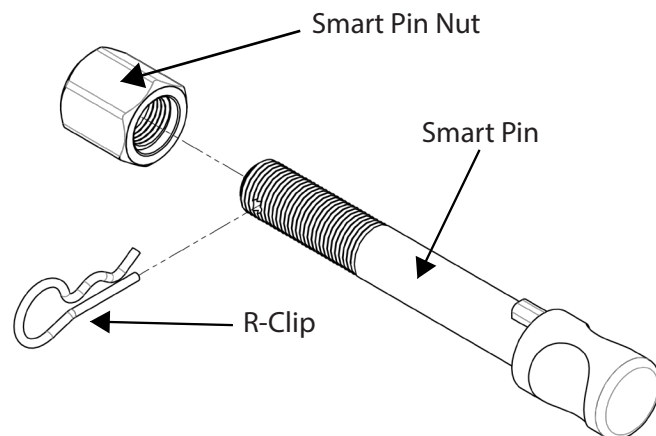
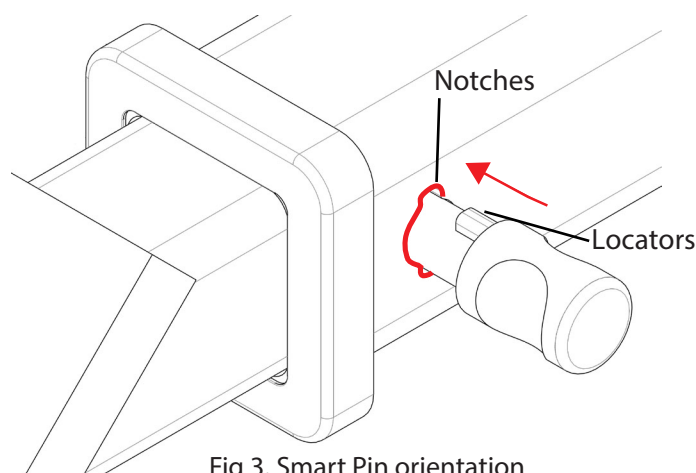
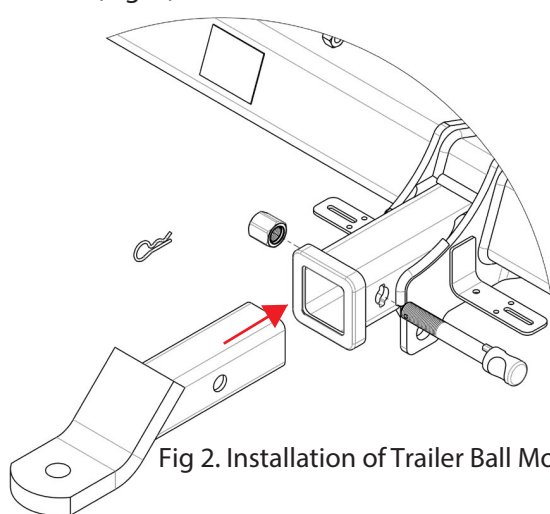

Fig 1. Smart Pin assembly

STEP 1 Insert Trailer Ball Mount (TBM) into towbar HITCHBOX, aligning hole in TBM SHANK with hole in HITCHBOX (Fig. 2).



STEP 2 Insert SMART PIN through hole in HITCHBOX and hole in TBM SHANK; ensure the LOCATORS are inserted into the NOTCHES in the HITCHBOX (Fig. 3).

STEP 3 Screw SMART PIN NUT onto SMART PIN; tighten SMART PIN NUT until finger tight, ensuring TBM is restrained from movement.

STEP 4 Tighten SMART PIN NUT by turning nut a further 1/8th of a turn in the clockwise direction using a 24mm spanner (Fig 4).

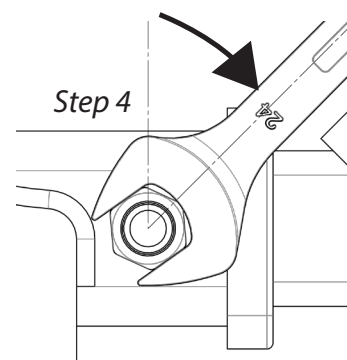

STEP 5 Install SMART PIN R CLIP through the hole on the SMART PIN (Fig. 1).

